

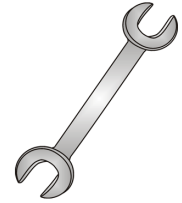

# Tow-Trust Towbars

Important: Please read General Notes overleaf before fitting



Issue 5

## TVW9 Volkswagen T5 / T6 Transporter & Shuttle

Item	Qty	Description	Item	Qty	Description
A	1	TVW9 Crossmember	D	2	M16 x 55 Bolts & Nyloc Nuts
B	2	Handed Side Arms	E	6	M12 x 40 (10.9) Bolts & S/P Washers (100Nm)
C	1	Extension	F	4	M12 x 35 Bolts & Nyloc Nuts
			G	4	M12x 40 Bolts & Nyloc Nuts
			H	6	12 x 30 Flat Washers
			J	8	12 x 25 Flat Washers

1. Lower the spare wheel.
2. Temporarily remove/ lower the plastic undertray.
3. Temporarily remove the rear light clusters. **NOTE:** Lift Door, Remove push in clips below the light clusters and remove the painted rear quarter panels. Twin Door, Remove plastic cover below door hinges.

### BUMPER REMOVAL: (Guide Only)

1. Remove fixings along lower edge, and around wheel arch liner. One tip fixing each side behind wheel arch liner.

### TOWBAR INSTALLATION:

1. Remove rear impact beam (Steel or Plastic) (This is Not refitted with the Towbar assembly and there is no need for any additional bumper supports).
2. Insert each correct side arm (Items B) into each chassis member and fix in place using Item E and Item H (Torque at this stage to 100Nm).
3. Using Item F with Item J fix Item A between each side arm (Items B).
4. Using Item G with Item J fix Item C to Item A.
5. Using Item D fix your desired ball bracket and wiring plate (not supplied in this kit) to Item C.
6. Fully tighten all nuts and bolts ensuring the Towbar is rigid, square and secure. (Item E to 100Nm)
7. Refit the plastic undertray, spare wheel, rear bumper and light clusters. **Note:** we advise you put you zip ties around Item A before the bumper is refitted due to clearance.

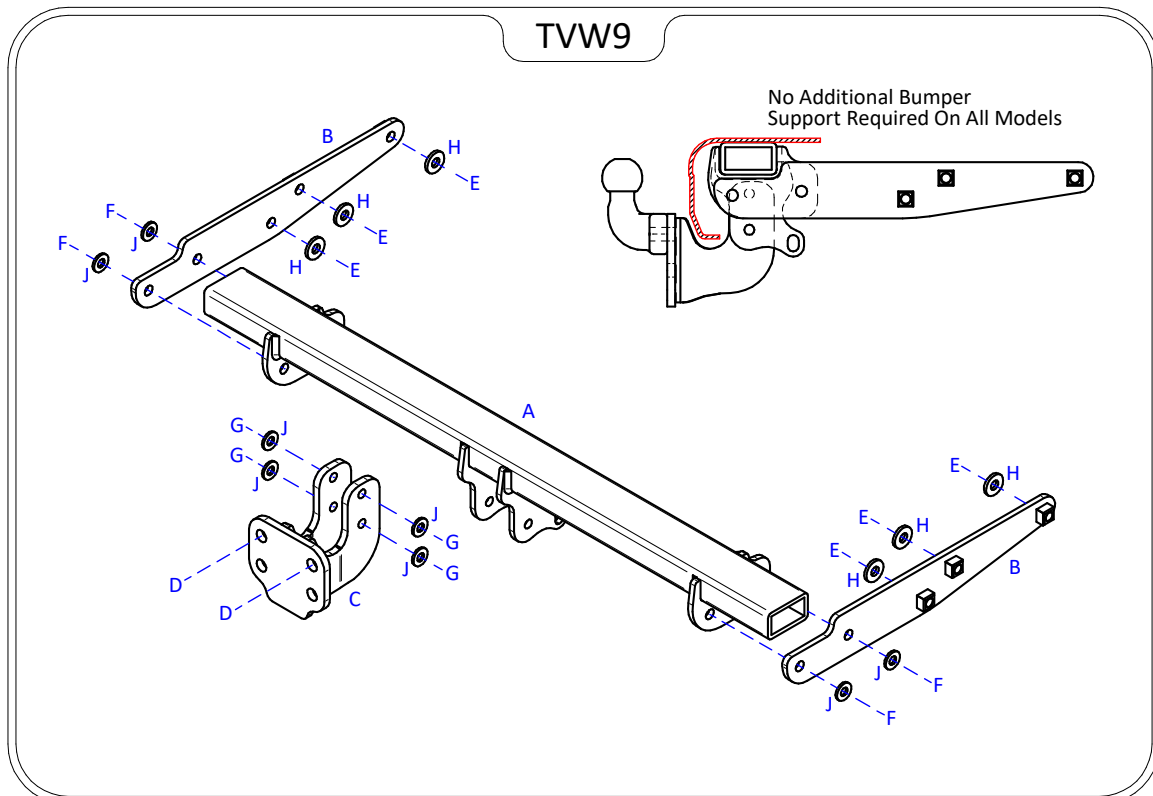

### Note:

1. Recommended Torque Setting for M12 Grade 10.9 -100 Nm. (For other Torque Settings see notes overleaf.)
2. Nose load limits and vehicle manufacturers trailer / caravan weight limits must be observed.